

405nm Fiber Coupled Diode Laser Subsystem

DS3-11444-K405EMSCN



Features:

- ◆ 405nm wavelength
- ◆ 20W output power
- ◆ 400μm core diameter
- ◆ 0.22NA

Applications:

- ◆ Laser Direct Writing
- ◆ Biological Detection
- ◆ 3D Printing

BWT, founded in 2003, is committed to the mission of "let the dream drive the light", the vision of becoming the "Global leader in laser solutions", and the value of "Outstanding innovation", providing diode laser, fiber laser, ultra-fast laser products and solutions to global customers.

The company pursues continuous innovation and insists on autonomous and controllable advanced process and technology. With Beijing headquarters as the core, BWT has successively established production and R&D centers in Jiangsu, Shanghai and Shenzhen, and invested in the construction of intelligent and digital production base in Tianjin. In order to build the world's highest level of technical strength and product quality, BWT set up a German subsidiary in 2020, introducing European quality standards, and taking a solid step for the internationalization of R&D, production and technological innovation.

Up to now, BWT has traded more than 10 million lasers worldwide. BWT's products are available in more than 70 countries and regions, applications involving industry, medical, commercial, scientific research, information and many other fields.

Version number	Change content	Change date
1.0	First edition	2021.09.17

405nm Fiber Coupled Diode Laser Subsystem

DS3-11444-K405EMSCN

Specifications (25°C)		Unit	DS3-11444-K405EMSCN
Optical Data ⁽²⁾	Output Power	W	20W
	Center wavelength	nm	405±5
	Spectral width (FWHM)	nm	≤6
	Power Range	%	10~100
Fiber Data	Core diameter	μm	400
	Numeric aperture	-	0.22
	Fiber output	-	Pluggable
	Fiber termination	-	Pluggable SMA905
Electrical Data	Power supply	V	DC 24V
	Drive mode	-	Constant current
	Operation mode	-	CW
	Control mode	-	RS232, I/O
	Operation temperature ⁽³⁾	°C	20~30
	The method of protection	-	Over voltage, Over current, Over temperature
Mechanical Parameters	Dimensions (LxWxH)	mm ³	223× 224× 63
Others	Cooling method	-	Water cooling
	Temperature Ambient in Operation	°C	15~30
	Storage temperature ⁽⁴⁾	°C	5~50
	Cooling requirement	-	Cooling capacity 100W, water flow: 2L/min
	Relative Humidity	%	5~80

(1) Consult BWT for other available options.

(2) Operating temperature defined by the package case. Acceptable operating range is 25°C, but performance may vary.

(3) A non-condensing environment is required for operation and storage.

(4) Operating temperature refers to the bottom plate temperature, the acceptable use of the temperature range of 15 degrees C to 35 degrees C, but the performance may be slightly different at different temperatures.

(5) Laser system appearance size, fiber appearance size, and connection head appearance size, please take the physical, sample picture for reference only.

405nm Fiber Coupled Diode Laser Subsystem

DS3-11444-K405EMSCN

Dimensions (mm)

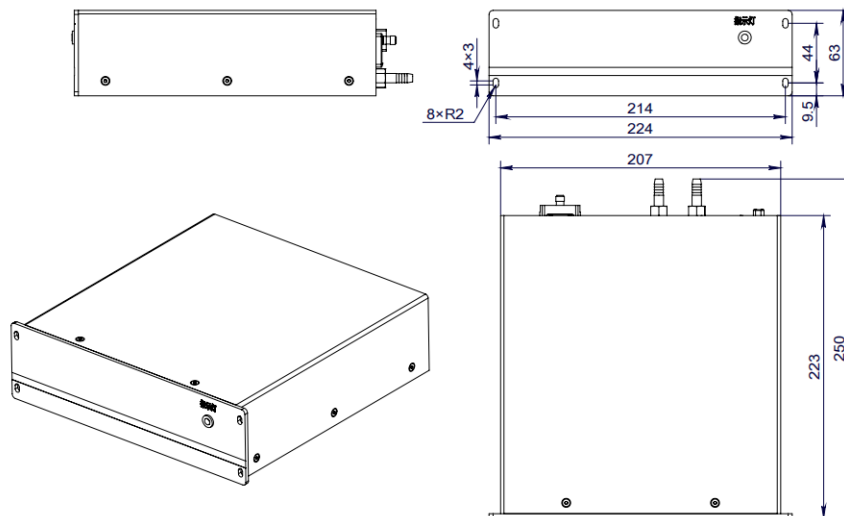

OPERATING NOTES

- ◆ Avoid eye and skin exposure to direct radiation during operation.
- ◆ Make sure the fiber output end is properly cleaned before operation of laser. Follow safety protocols to avoid injury when handling and cutting the fiber.
- ◆ Laser diode must be used according to the specifications.
- ◆ Temperature Ambient in Operation ranges from 15°C to 30°C.
- ◆ Storage temperature ranges from 5°C to 50°C.

Declaration: information and specifications contained herein are deemed to be reliable and accurate. BWT Beijing reserves the right to change, alter or modify the design and specifications of these products at any time without notice.20-1

