

976nm 460W High Power Fiber Coupled Diode Laser

K976-A0-460.0W-22022-D

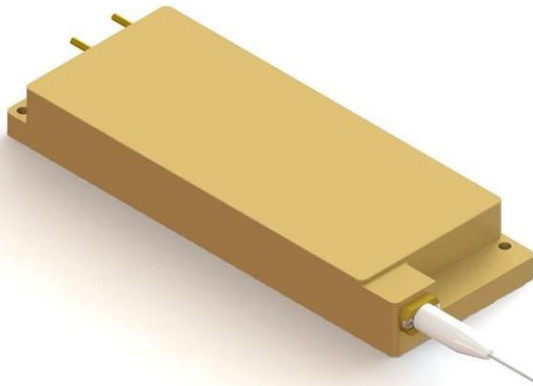

Features:

- ◆ 976nm wavelength
- ◆ 460W output power
- ◆ 220 μ m fiber core diameter
- ◆ 0.22 NA
- ◆ 1020nm~1200nm feedback protection

Applications:

- ◆ Fiber laser pumping

BWT, founded in 2003, is committed to the mission of "let the dream drive the light", the vision of becoming the "Global leader in laser solutions", and the value of "Outstanding innovation", providing diode laser, fiber laser, ultra-fast laser products and solutions to global customers.

The company pursues continuous innovation and insists on autonomous and controllable advanced process and technology. With Beijing headquarters as the core, BWT has successively established production and R&D centers in Jiangsu, Shanghai and Shenzhen, and invested in the construction of intelligent and digital production base in Tianjin. In order to build the world's highest level of technical strength and product quality, BWT set up a German subsidiary in 2020, introducing European quality standards, and taking a solid step for the internationalization of R&D, production and technological innovation.

Up to now, BWT has traded more than 10 million lasers worldwide. BWT's products are available in more than 70 countries and regions, applications involving industry, medical, commercial, scientific research, information and many other fields.

Version number	Change content	Change date
00	First edition	2021.10.10

976nm 460W High Power Fiber Coupled Diode Laser

K976-A0-460.0W-22022-D

Specifications (25°C)		Symbol	Unit	K976-A0-460.0W-22022-D		
				Minimum	Typical	Maximum
Optical Data ⁽¹⁾	CW Output Power	P _o	W	460	-	-
	Center Wavelength	λ _c	nm	976±3		
	Spectral Width(FWHM)	Δλ	nm	-	4	6
	Wavelength Shift with Temperature	Δλ/ΔT	nm/°C	-	0.3	-
	0.17/0.22NA	-	%	90	95	-
Electrical Data	Electrical-to-Optical Efficiency	PE	%	-	49	-
	Operating Current	I _{op}	A	-	33	35
	Threshold Current	I _{th}	A	-	1.4	-
	Operating Voltage	V _{op}	V	-	28	31
	Slope Efficiency	η	W/A	-	14.5	-
Fiber Data	Core Diameter	D _{core}	μm	-	220	-
	Cladding Diameter	D _{clad}	μm	-	242	-
	Numeric Aperture	NA	-	-	0.22	-
	Fiber Length	L _f	m	-	2	-
	Fiber Loose Tubing Diameter	-	mm	0.9		
	Minimum Bending Radius	-	mm	88	-	-
	Fiber Termination	-	-	FF		
Feedback Isolation	Wavelength Range	-	nm	1020~1200		
	Isolation	-	dB	-	30	-
Others	ESD	V _{esd}	V	-	-	500
	Storage Temperature ⁽²⁾	T _{st}	°C	-20	-	70
	Lead Soldering Temp	T _{is}	°C	-	-	260
	Lead Soldering Time	t	sec	-	-	10
	Operating Case Temperature ⁽³⁾	T _{op}	°C	15	-	35
	Relative Humidity	RH	%	15	-	75

(1) Data measured under operation output at 460W@25°C.

(2) A non-condensing environment is required for operation and storage.

(3) Operating temperature defined by the package case. Acceptable operating range is 15°C~35°C, but performance may vary.

976nm 460W High Power Fiber Coupled Diode Laser
K976-A0-460.0W-22022-D

Package Dimensions (mm)

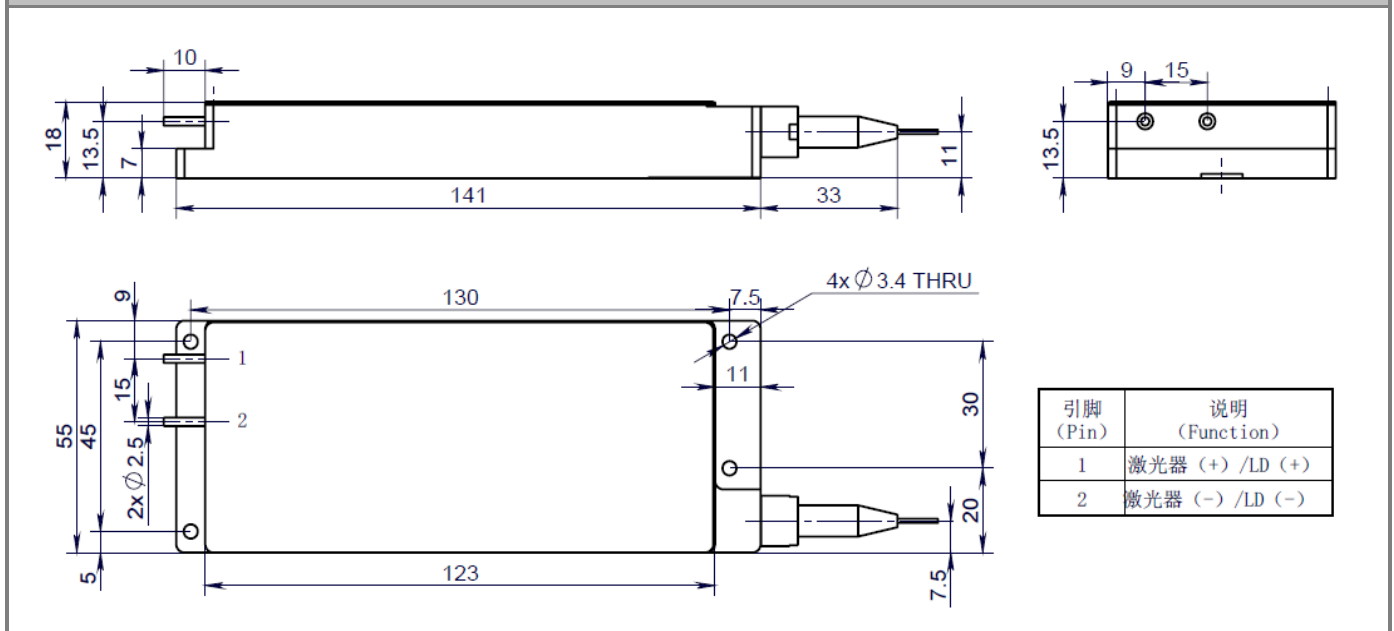

OPERATING NOTES

- ◆ Avoid eye and skin exposure to direct radiation during operation.
- ◆ ESD precautions must be taken during storage, transportation and operation.
- ◆ Short-circuit is required between pins during storage and transportation.
- ◆ Please connect pins to wires by solder instead of using socket when operation current is higher than 6A. Soldering point should be close to the middle of the pins. Soldering temperature should be lower than 260°C and time shorter than 10 second.
- ◆ Make sure the fiber output end is properly cleaned before operation of laser. Follow safety protocols to avoid injury when handling and cutting the fiber.
- ◆ Use constant current power supply to avoid surge current during operation.
- ◆ Laser diode must be used according to the specifications.
- ◆ Laser diode must work with good cooling.
- ◆ Operation temperature ranges from 15°C to 35°C .
- ◆ Storage temperature ranges from -20°C to +70°C .

976nm 460W High Power Fiber Coupled Diode Laser
K976-A0-460.0W-22022-D



Declaration: information and specifications contained herein are deemed to be reliable and accurate. BWT Beijing reserves the right to change, alter or modify the design and specifications of these products at any time without notice.