

808nm 70W Fiber Coupled Diode Laser K808DA5RN-70.00W

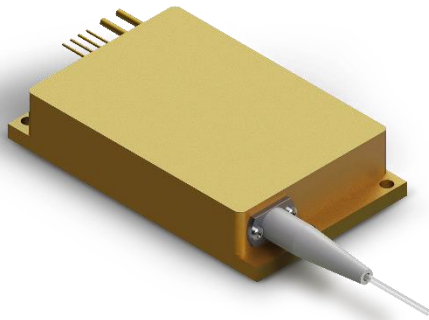

Features:

- ◆ 808nm wavelength
- ◆ 70W output power
- ◆ 105 μ m fiber core diameter
- ◆ 0.22 NA
- ◆ 1020nm~1200nm feedback protection

Applications:

- ◆ Solid-state laser pumping
- ◆ Medical application
- ◆ Material processing

BWT, founded in 2003, is committed to the mission of "let the dream drive the light", the vision of becoming the "Global leader in laser solutions", and the value of "Outstanding innovation", providing diode laser, fiber laser, ultra-fast laser products and solutions to global customers.

The company pursues continuous innovation and insists on autonomous and controllable advanced process and technology. With Beijing headquarters as the core, BWT has successively established production and R&D centers in Jiangsu, Shanghai and Shenzhen, and invested in the construction of intelligent and digital production base in Tianjin. In order to build the world's highest level of technical strength and product quality, BWT set up a German subsidiary in 2020, introducing European quality standards, and taking a solid step for the internationalization of R&D, production and technological innovation.

Up to now, BWT has traded more than 10 million lasers worldwide. BWT's products are available in more than 70 countries and regions, applications involving industry, medical, commercial, scientific research, information and many other fields.

808nm 70W Fiber Coupled Diode Laser K808DA5RN-70.00W

Specifications (25°C)		Symbol	Unit	K808DA5RN-70.00W		
				Minimum	Typical	Maximum
Optical Data ⁽¹⁾	CW Output Power	P _o	W	70	-	-
	Center Wavelength	λ_c	nm	808±3		
	Spectral Width(FWHM)	$\Delta\lambda$	nm	-	6	-
	Wavelength Shift with Temperature	$\Delta\lambda/\Delta T$	nm/°C	-	0.3	-
Electrical Data	Electrical-to-Optical Efficiency	PE	%	-	45	-
	Threshold Current	I _{th}	A	-	1.5	-
	Operating Current	I _{op}	A	-	9	11
	Operating Voltage	V _{op}	V	-	-	18
	Slope Efficiency	η	W/A	-	8	-
Fiber Data	Core Diameter	D _{core}	μm	-	105	-
	Cladding Diameter	D _{clad}	μm	-	125	-
	Numeric Aperture	NA	-	-	0.22	-
	Fiber Length	L _f	m	-	2.0	-
	Fiber Loose Tubing Diameter	-	mm	-	3.0	-
	Minimum Bending Radius	-	mm	50	-	-
	Fiber Termination	-	-	SMA905		
Feedback Isolation	Wavelength Range	-	nm	1020~1200		
	Isolation	-	dB	-	30	-
Others	ESD	V _{esd}	V	-	-	500
	Storage Temperature ⁽²⁾	T _{st}	°C	-20	-	70
	Lead Soldering Temp	T _{is}	°C	-	-	260
	Lead Soldering Time	t	sec	-	-	10
	Operating Case Temperature ⁽³⁾	T _{op}	°C	15	-	35
	Relative Humidity	RH	%	15	-	75

(1) Data measured under operation output at 70W@25°C.

(2) A non-condensing environment is required for operation and storage.

(3) Operating temperature defined by the package case. Acceptable operating range is 15°C~35°C, but performance may vary.

808nm 70W Fiber Coupled Diode Laser
K808DA5RN-70.00W

Package Dimensions (mm)

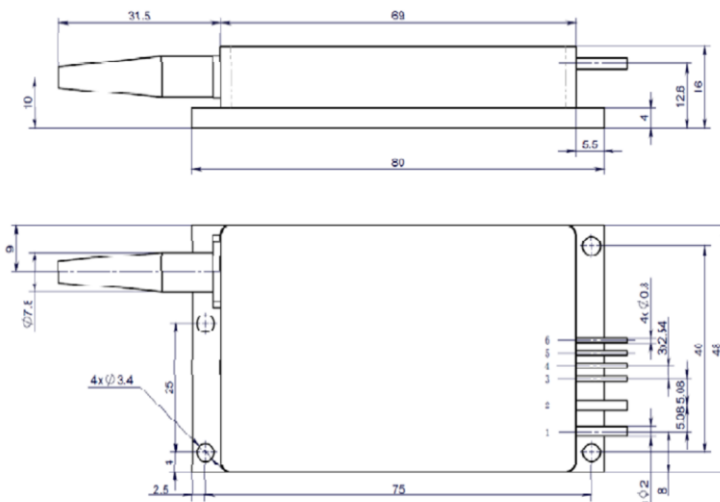

Pin	Function
1	LD (+)
2	LD (-)
3	Thermistor*
4	Thermistor*
5	PD(N)*
6	PD(P)*

*: Optional function

OPERATING NOTES

- ◆ Avoid eye and skin exposure to direct radiation during operation.
- ◆ ESD precautions must be taken during storage, transportation and operation.
- ◆ Short-circuit is required between pins during storage and transportation.
- ◆ Please connect pins to wires by solder instead of using socket when operation current is higher than 6A. Soldering point should be close to the middle of the pins. Soldering temperature should be lower than 260°C and time shorter than 10 second.
- ◆ Make sure the fiber output end is properly cleaned before operation of laser. Follow safety protocols to avoid injury when handling and cutting the fiber.
- ◆ Use constant current power supply to avoid surge current during operation.
- ◆ Laser diode must be used according to the specifications.
- ◆ Laser diode must work with good cooling.
- ◆ Operation temperature ranges from 20°C to 30°C .
- ◆ Storage temperature ranges from -20°C to +70°C .



Declaration: information and specifications contained herein are deemed to be reliable and accurate. BWT Beijing reserves the right to change, alter or modify the design and specifications of these products at any time without notice.21-12